

Complete Solutions for Small Field Applications

PRODUCT OVERVIEW

When small things matter.



OCTAVIUS Detector 1600 SRS

with OCTAVIUS 4D

OCTAVIUS Detector 1600 SRS Unique Detector Properties

- ▶ Advancement of well-established OCTAVIUS Detector 1000 SRS with > 50% more chambers
- ▶ 1521 liquid-filled ionization chambers with an active volume of $2.5 \times 2.5 \times 0.5 \text{ mm}^3$ (0.003 cm^3)
- ▶ Enlarged active detector area with $15 \times 15 \text{ cm}^2$
- ▶ 729 ionization chambers in enlarged high-resolution center area of $6.5 \times 6.5 \text{ cm}^2$
- ▶ Spatial resolution 2.5 mm in center area
- ▶ For filmless patient plan verification and machine specific QA
- ▶ Excellent error detection for all stereotactic treatment plans

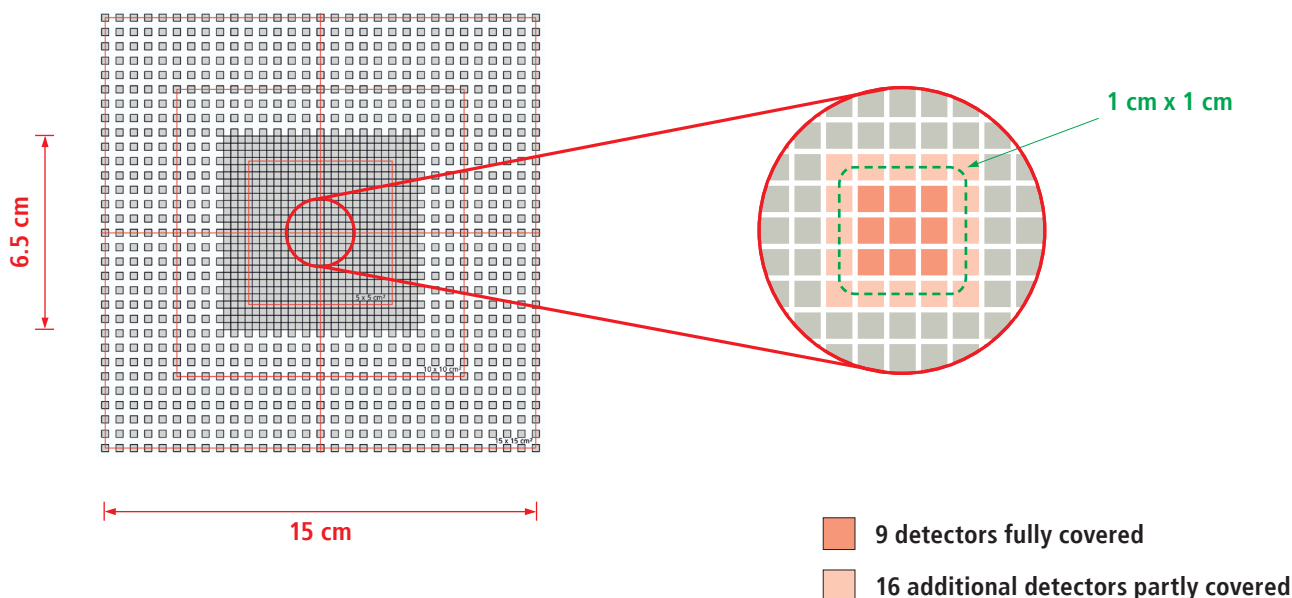

Optimal size for multi-target SRS treatments

Stereotactic treatments require high radiological and, most importantly, spatial precision which should be checked for each patient individually.

Besides 2D patient plan verification OCTAVIUS Detector 1600 SRS allows independent 3D patient plan verification when combined with OCTAVIUS 4D. Due to its high spatial resolution (2.5 mm) and its large detector area of 15 x 15 cm² OCTAVIUS 1600 SRS allows patient specific QA of SRS treatments, especially of those including multiple, widely-spaced target volumes (e.g. multiple metastases in stereotactic brain applications).

- 3D verification of multiple, widely-spaced target volumes within a single measurement
 - No repeated and time-consuming measurements of individual/grouped target volumes requiring couch or detector shifts
- Only 3D patient specific QA guarantees perfect coverage of multiple target volumes in different planes within a single measurements
- Calculation of 3D volume gamma metrics

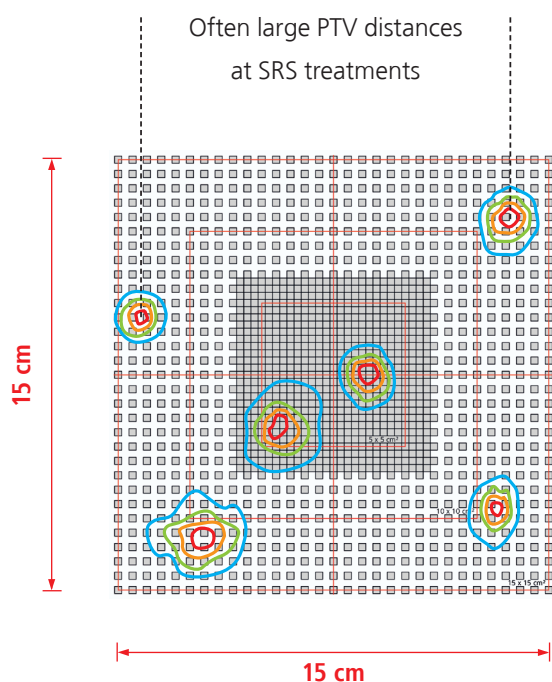

Recently TPS and linac manufacturers introduced new solutions for efficient planning of SRS treatments of multiple target volumes with a single isocenter (e.g. Varian HyperArc and Brainlab Elements® Multiple Brain Mets SRS). These applications often include multiple widely-spaced target volumes easily covered with the large detector area of 15 x 15 cm².

Patient specific phantom adaption

For measurements with OCTAVIUS 4D the OCTAVIUS Detector 1600 SRS can be used with the OCTAVIUS Top SRS plus. With a diameter of 21 cm the resulting homogeneous cylinder geometry adapts the anatomy of a human head perfectly in SRS treatments of the brain.

In addition, for either SBRT procedures (e.g. stereotactic treatment of lung metastases) or other clinical entities the OCTAVIUS Detector 1600 SRS can be combined with the 32 cm OCTAVIUS Top Standard, emphasizing its multifunctional nature.

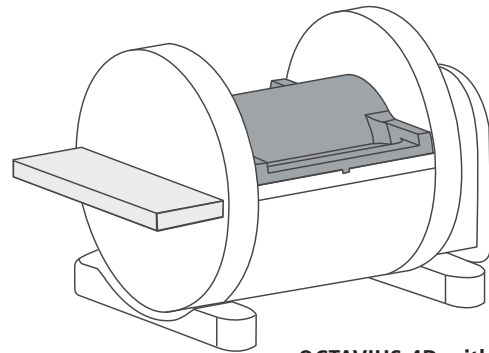

OCTAVIUS 4D with 1600 SRS + Top SRS plus (Ø 21 cm)

Patient dose distribution of a multiple target SRS treatment

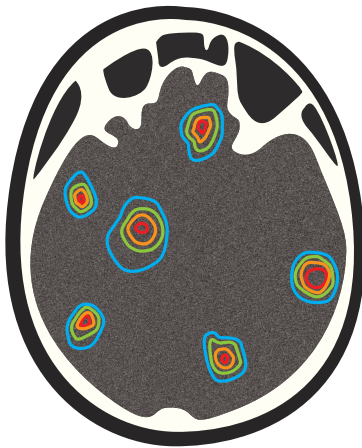

Phantom dose distribution

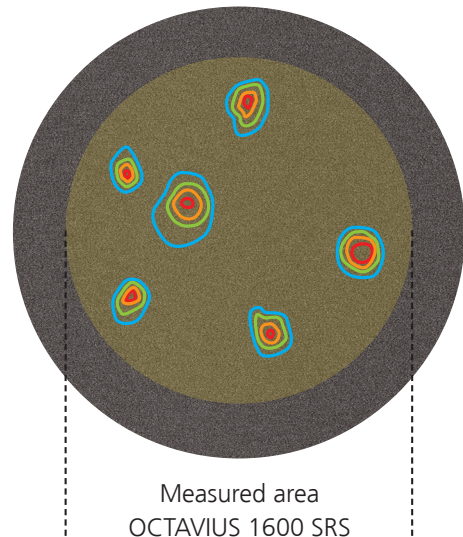

Measured area
OCTAVIUS 1600 SRS

Commissioning of SRS/SBRT techniques

PTW OCTAVIUS Detectors have proven to be accurate tools for planar dose measurements. Especially for radiotherapy departments implementing SRS/SBRT delivery techniques into their clinical practice, OCTAVIUS 1600 SRS can support and facilitate the commissioning process.



True verification of non-coplanar SRS treatments

Conventional SRS treatments and especially modern single-isocenter SRS treatments, such as Varian HyperArc™ or Brainlab Elements® Multiple Brain Mets SRS, use a mixture of coplanar and non-coplanar beams improving the dose conformity. Together with OCTAVIUS 4D the new OCTAVIUS Detector 1600 SRS represents an ideal tool for true 3D verification of SRS treatments with non-coplanar beams.

- True and simple 3D verification of SRS deliveries with non-coplanar beams
 - Verification of the real patient plan - no need to collapse couch angles to 0°
 - VeriSoft automatically reads out all couch angles from the DICOM RT Plan and takes them into account for dose reconstruction
- Arbitrary couch angles up to 90°/270° supported
 - No limitation of couch angles with respect to beam quality

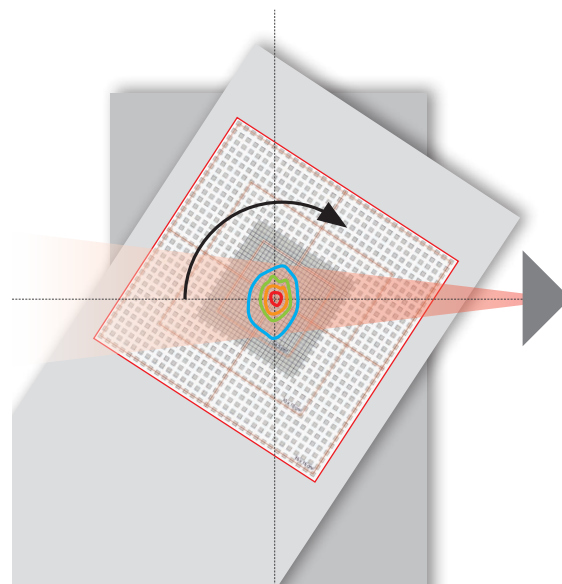

VeriSoft takes arbitrary couch angles into account

Technical specifications

OCTAVIUS Detector 1600 SRS

Type of product:	Two-dimensional array with 1521 liquid-filled ionization chambers
Application:	IMRT and VMAT patient plan verification Machine-specific QA Online beam adjustment
Measuring quantities:	Absorbed dose rate and absorbed dose
Range of use:	0.1 - 24 Gy/min
Resolution:	0.1 mGy, 0.1 mGy/min
Dead time:	Zero
Display cycle:	100 - 800 ms
Type of detectors:	Plane-parallel, liquid-filled ionization chambers
Detector layout:	Center area (6.5 cm x 6.5 cm): spacing 2.5 mm Outer area (15 cm x 15 cm): spacing 5 mm
Nominal response:	16 nC/Gy
Size of detectors:	2.5 mm x 2.5 mm x 0.5 mm (0.003 cm ³)
Active detector area:	15 cm x 15 cm
Outer dimensions:	300 mm x 420 mm x 22 mm (W x D x H)
Weight:	5.9 kg

Ordering information

L981626	OCTAVIUS 4D system, 1600 SRS
L981628	OCTAVIUS Detector 1600 SRS measuring system
L981627	OCTAVIUS I, 1600 SRS incl. VeriSoft software
T43037	Marker plate CyberKnife®

OCTAVIUS 4D modular phantom

Design:	Motorized, modular phantom, consisting of base unit with four exchangeable tops
Dimensions:	Phantom diameter 320 mm, length 343 mm
Weight:	Base unit 20.7 kg
Angle range:	± 360°
Material:	Polystyrene
Density:	1.05 g/cm ³

Phantom tops

Top Standard:	Phantom diameter 320 mm weight 8.9 kg
Top SRS:	Phantom diameter 170 mm weight 2.3 kg
Top SRS plus:	Phantom diameter 210 mm weight 3.7 kg
Top Linac QA:	50 mm water-equivalent build-up weight 2.2 kg

Ordering information

T40063	OCTAVIUS Rotation Unit modular
T40063.1.004	OCTAVIUS Top Standard
T40063.1.002	OCTAVIUS Top SRS
T40063.1.005	OCTAVIUS Top SRS plus
T40063.1.003	OCTAVIUS Top Linac QA

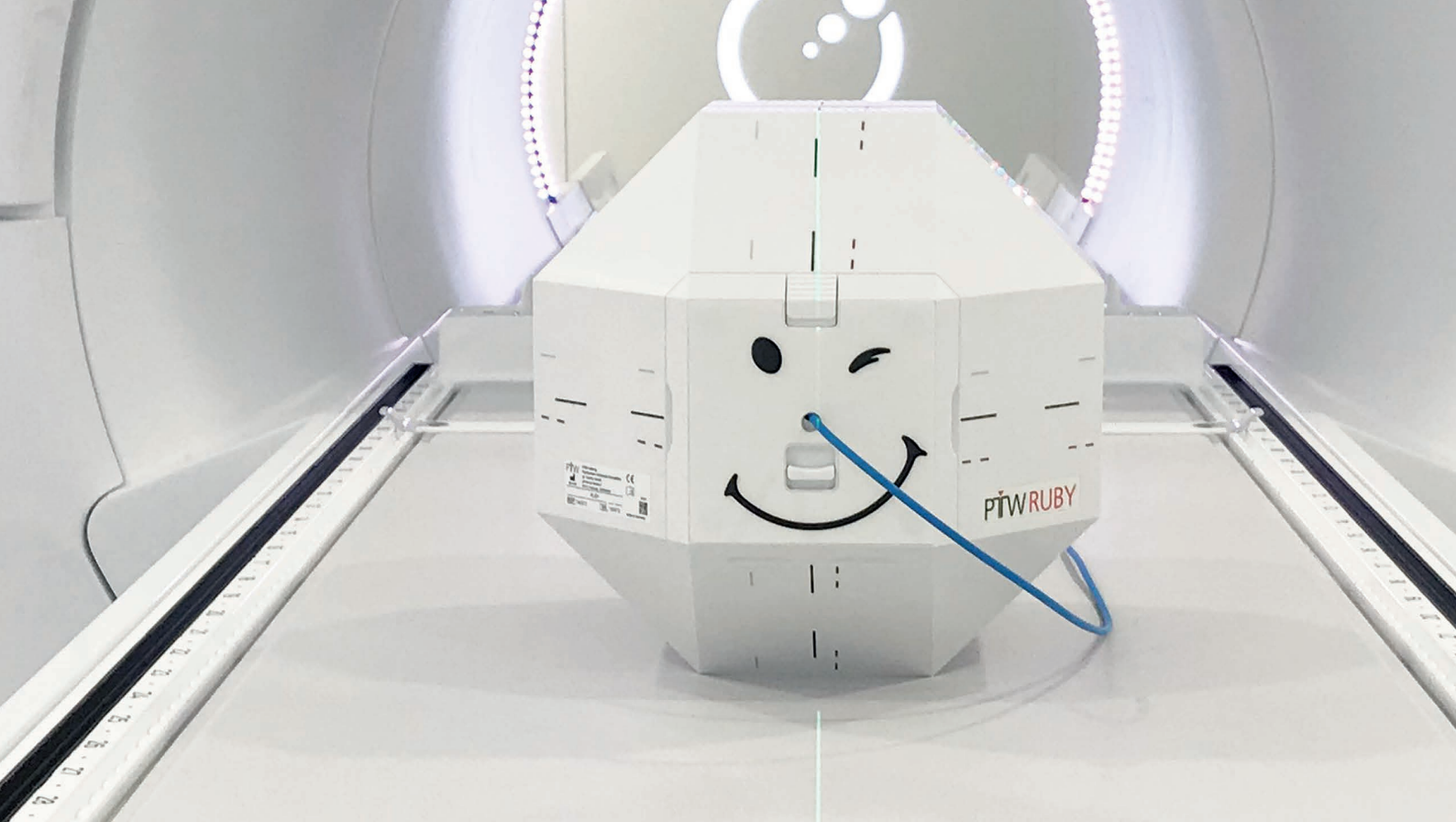

RUBY®



The modular phantom platform for high-precision radiotherapy and SRS/SBRT QA

One phantom. Multiple inserts. All tasks.

- ▶ Technologically advanced, modular phantom platform with powerful, ready-to-use application-specific inserts
- ▶ Unrivaled flexibility – add and combine inserts as needed
- ▶ Fast, simple system setup and operation – insert and start testing
- ▶ Comprehensive end-to-end testing of the entire SRS/SBRT treatment process with the System QA insert
- ▶ Measurement-based patient-specific plan verification, including non-coplanar treatments, with film and different detector types
- ▶ Alignment checks of the entire system, including 6D couches
- ▶ CT markers in phantom and all inserts for enhanced visibility
- ▶ Tissue-equivalent materials that follow ICRU-44/-46 standards
- ▶ Supports the latest radiotherapy treatment techniques and systems, including SRS, SBRT, SGRT, Varian Halcyon™ and Elekta Unity
- ▶ All components designed and manufactured with submillimeter precision
- ▶ Integrated, compatible solution – phantom, inserts, detectors from one single source



System QA

Comprehensive end-to-end testing of the entire process with the RUBY System QA insert

- ▶ ICRU-based tissue-equivalent materials (brain, lung and bone) for electron density check, TPS contouring QA and enhanced visibility in kV, CBCT and MV images
- ▶ MRI visible cavities enable check of CT/MRI registration and qualitative MRI distortion check
- ▶ Detector positioning at the center of the insert marked with CT markers made of bone equivalent material

Systematic QA of multiple metastases treatments with one isocenter with RUBY System QA Multimet insert

- ▶ Enables positioning of three detectors at different positions within the insert marked with CT markers made of bone equivalent materials
- ▶ Contains three cylinders made of bone equivalent material for enhanced visibility in kV, CBCT and MV images
- ▶ Enables systematic QA of multi metastases treatments, e.g. Varian HyperArc™

Linac QA

- ▶ Daily checks of IGRT and SGRT positioning accuracy, including remote-controlled couches (including 6D) as recommended by AAPM TG-179 and TG-142
- ▶ Tissue-equivalent bone structures for enhanced visibility in kV and MV images
- ▶ High-density radiopaque sphere at isocenter for easy Winston-Lutz testing

Patient QA

Detector Insert

- ▶ One insert for fast, accurate single-point dose measurements with different detector types
- ▶ Unique “Plug and Measure” convenience using detector holders – no need to replace phantom or exchange inserts

Film Insert

- ▶ Homogeneous insert designed for use with high-resolution radiochromic films
- ▶ Film-based patient plan verification for high-precision radiotherapy and SBRT/SRS

Technical specifications

RUBY phantom

Design:	Polyhedron phantom with octahedral symmetry (10 cm side length) and cubic hole for QA test inserts in phantom center
Laser alignment marks:	<p>Black: phantom center</p> <p>Gray: translational shift (coronal: 18 mm; transversal: 14 mm; sagittal: - 25 mm)</p> <p>Red: translational and rotational shift (coronal: -12 mm, rotation -1°; transversal: -10 mm, rotation 2.5°; sagittal: 15 mm, rotation -1.5°)</p>
Material:	Polystyrene
Density:	1.05 g/cm ³
Dimensions:	241.4 mm x 231.4 mm x 241.4 mm (W x D x H)
Weight:	6.7 kg

Ordering information

RUBY sets

L981636	RUBY System QA Set
L981637	RUBY Linac QA Set
L981638	RUBY Patient QA Set
L981660	RUBY All in Set
L981654	RUBY Head Phantom Set MultiMet

Individual ordering

T40072.1.001	RUBY base phantom
T40072.1.800	RUBY head phantom
T40072.1.100	RUBY Patient QA detector insert
T40072.1.200	RUBY Linac QA insert
T40072.1.300	RUBY System QA insert
T40072.1.400	RUBY Patient QA film insert
T40072.1.500	RUBY insert System QA – MultiMet
T40072.1.030	RUBY tilted base
Single detector holders upon request	



VERIQA®



The modular software platform for comprehensive Patient QA

Streamlining workflows based on proven technologies

- ▶ One Platform. Flexible and Scalable.
From visualization and evaluation to verification and reporting, VERIQA is an all in one software built on future-proof client-server architecture.
- ▶ Automated Workflows. Streamlined Operations.
Take your workflow efficiency to a next level by automating your patient-specific assurance.
- ▶ Track. Trend. Monitor.
Track and analyse your results with the automated integration of Track-it.
- ▶ Monte Carlo dose calculations: Fast and precise.
VERIQA calculates dose using the well-established SciMoCa™ Monte Carlo algorithm known for its accuracy and reliability. Use this gold standard method to automatically evaluate your treatment plans with minimum effort in 3D.
- ▶ Automated plan verification:
VERIQA gives you the ability to select the best method for specific verification needs. Choose between independent dose calculation, pre-treatment and in vivo EPID dosimetry, or any combination thereof.
- ▶ Advanced 3D EPID Dosimetry:
Based on the clinically proven algorithm, the VERIQA RT EPID 3D is the new Patient QA module to come for true 3D pre-treatment and in vivo EPID dosimetry. Since 2005, the algorithm has been successfully used in more than 75,000 patient treatments at The Netherlands Cancer Institute, Antoni van Leeuwenhoek Hospital (NKI-AVL).

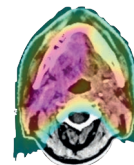
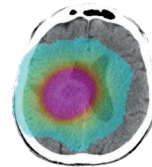
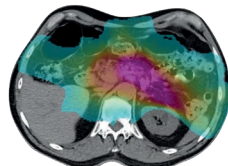
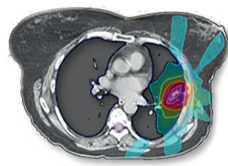

	LUNG SBRT	Pancreas	Brain	Head and Neck
	3D / 7 beams 6 MV FFF	VMAT / 2 arcs / 180 CP ¹ 6 MV - SIB ²	VMAT / 1arc / 90 CP ¹ 6 MV FFF	VMAT / 2arc / 180 CP ¹ 6 MV - SIB ²
PTV volume	46.45 cm ³	589.26 cm ³	264.48 cm ³	907.74 cm ³
Dose grid size	3 x 3 x 3 mm	3 x 3 x 3 mm	2 x 2 x 2 mm	2 x 2 x 2 mm
MC accuracy	1 %	1 %	0.5 %	0.5 %
Calculation time	12 sec	30 sec	46 sec	246 sec

Calculated on a dual 12-core Intel Xeon Silver 4214 2.2 GHz server with hyperthreading (48 logical cores).

VERIQA RT MonteCarlo 3D

3D dose calculation with SciMoCa. Accurate. Fast. Automated.

Your advantages

- ▶ Monte Carlo simulations are the most accurate method for dose calculation in radiotherapy treatment planning. With its ability to simulate the physics of photons and charged particles transport through matter, Monte Carlo can accurately compute the dose under almost any circumstances
- ▶ VERIQA RT MonteCarlo 3D comes pre-installed on a powerful server, allowing for high-speed dose computations. Calculation results are available in less than 2 minutes
- ▶ Due to its specific beam modelling process, which is based on water phantom measurements, VERIQA RT MonteCarlo 3D performs truly independent dose calculations for a reliable secondary plan check

“Secondary dose calculation systems should be completely independent from primary TPS. Accurate matching between the secondary dose calculational systems and the dosimetric characteristics of the linac is thereby essential for truly independent and valuable dose evaluation.”

Prof. Sotiri Stathakis, Ph.D.
University of Texas Health Science
Center, San Antonio



Visualization

Access, visualize and compare your patient specific plan verification with **RT VIEW**, a full-featured easy to use DICOM Viewer

Evaluation

Evaluate your treatment plans using image registration, dose accumulation and contouring tools with **RT Evaluate**. Use RT Evaluate to further analyse your patient specific QA with comprehensive 3D-gamma-and DVH analysis capabilities.

Pre-Treatment Verification

Use established, high standard Monte Carlo simulations to evaluate your patient plans with independent **RT MonteCarlo 3D** dose calculations.

Pre-Treatment and in vivo Verification

Benefit from a fully automated solution for both pre-treatment and in vivo EPID dosimetry enabling true 3D patient dose reconstruction from the acquired images with **VERIQA RT EPID 3D** *.

* The module RT EPID 3D will be available in the near future.

ptwveriqa.com



UNIDOS® Tango



The Smart Reference Class Electrometer

Less time. More safety. Intelligent Detector Recognition (IDR)

UNIDOS Tango is the first electrometer worldwide that automates detector management and identification. By using detector-specific data matrix codes and intelligent 2D code scanning technology, it saves time and eliminates the chance for mistyped data, particularly in clinical environments with multiple electrometers and different detectors in use.

All in one code.

Each PTW detector suitable for reference dosimetry comes with a calibration certificate which also contains a unique data matrix code (DMC). It stores all detector-specific information, e.g., the calibration factor, calibration date and the name and serial number of the detector.

Scan Code.

Updating the detector database of your UNIDOS Tango is very easy: Simply tap the DMC icon in the detector database, then point the data matrix code on your calibration certificate at the device camera. The built-in 2D code scanner reads the code and automatically enters all detector-specific information into the detector database of your UNIDOS Tango.

Identify detector.

Ready to perform a measurement? Hold the data matrix code that is printed on the label of your measurement detector in front of the device camera. The built-in 2D code scanner reads the code and calls up the correct detector simply by matching the data stored on the code to an entry in the detector database.



Touchscreen



Ethernet/LAN



WiFi

Exceptional

As a secondary standard reference class electrometer that exceeds IEC and IPEM performance requirements, UNIDOS Tango delivers fast, reliable and highly accurate results across all applications. Equipped with industry-leading amplifier technology, it is exceptionally stable and ready for use immediately upon start. With the widest measurement range and best available resolution (0.1 fA) in the market, the new UNIDOS Tango is your tool of choice for high-precision measurements, e.g., in small field dosimetry.

Automated

Reduce setup time and improve measurement consistency with individual user profiles. Favorite device settings and detector parameters for frequent or specific measurement tasks, e.g., preferred measurement detector, user-defined correction factor and measurement range, can be saved as password-protected user profiles.

Technical specifications

UNIDOS Tango

Type of product:	Reference class electrometer
Channel:	1
Dimensions:	201 x 122 mm x 253 mm (W x H x D incl. feet)
Weight:	3 kg
Measurement ranges (according to IEC 60731, reference class):	
	Current: 400 fA ... 2.6 μ A
	Charge: 4 pC ... 9.3 C
Resolution:	Current: 0.1 fA
	Charge: 1 fC
Repeatability:	$\leq \pm 0.25\%$ ($\leq \pm 0.25\%$ IEC 60731)
Long-term stability:	$\leq \pm 0.1\%$ ($\leq \pm 0.5\%$ over one year, IEC 60731)
Response time	< 1.5 s (< 3 s (90 % response), IEC 60731)
Non-linearity	$\leq \pm 0.25\%$ ($\leq \pm 0.5\%$ IEC 60731)
Zero drift	$\leq \pm 0.25\%$ ($\leq \pm 0.5\%$ IEC 60731)
Zeroing	typ. 85 s

Intuitive

Its brilliant 5" capacitive touchscreen provides a clean, easy-to-navigate multi-lingual user interface, which gives you instant access to all relevant settings. Measurement readings and other important data are always clearly visible on the screen.

Connected

Use UNIDOS Tango as a standalone electrometer with intuitive touchscreen operation or control it remotely from your PC/laptop. Access its built-in webserver using any WiFi-enabled device, like your smartphone or tablet.

Versatile

Access the last 50 measurements and quickly calculate mean value and standard deviation right on the spot. A detector database with ready-to-use detector templates makes it easy for you to manage up to 100 different detectors and their calibration data. Export measurement values to the Track-it data management software for documentation and constancy monitoring using optional BeamDose software.

Ordering information

L981629	UNIDOS Tango, connecting system M
L981630	UNIDOS Tango, connecting system BNT
L981631	UNIDOS Tango, connecting system TNC
L981632	UNIDOS Romeo, connecting system M
L981633	UNIDOS Romeo, connecting system BNT
L981634	UNIDOS Romeo, connecting system TNC
S080053	BeamDose software

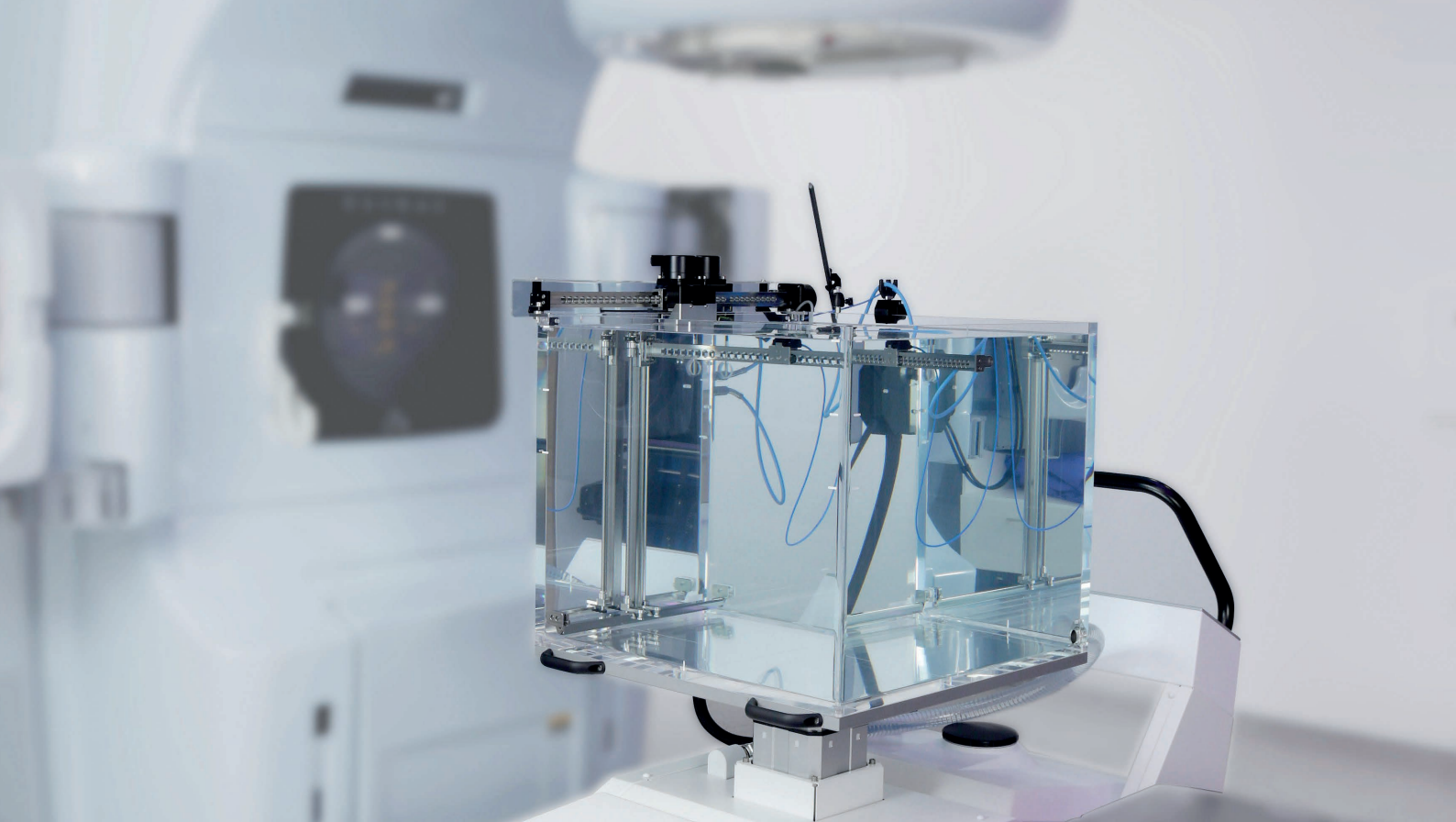

BEAMSCAN®



Motorized water phantom - also for small fields

True all-in-one 3D water scanning system with wireless auto setup and operation

Measurements in small fields are always a challenge and at the same time a commitment for PTW to manage these measurements at its best.

The new BEAMSCAN Software with dedicated features for small field dosimetry in combination with the high mechanical precision and the Auto Setup features makes BEAMSCAN the best choice for small field dosimetry.

- ▶ Advanced data processing based on Artificial Intelligence
- ▶ Fast, fully automated, wireless setup
- ▶ Patented, fully automatic virtual tank leveling
- ▶ Wireless operation and data transfer
- ▶ Fast scanning (up to 20 mm/s)
- ▶ Supports Varian Halcyon™
- ▶ Continuous and step-by-step scanning mode
- ▶ Fully automatic water filling/draining
- ▶ Auto field alignment

The measured beam inclination will be taken into account for other measurements.

Output factors are always measured in the beam maximum when the new function "Search maximum" is used before measurement of output factors.

- ▶ Advanced stainless steel worm drive with wave prevention
- ▶ Built-in, high-precision electrometer
- ▶ Reference-class Semiflex 3D ionization chambers as detectors, suitable for a wide range of field sizes
- ▶ TPR measurement already included
- ▶ Integrated evaporation control
- ▶ Easy clip-in detector installation with new TRUFIX BS
- ▶ Water tank with inclined bottom for complete draining
- ▶ Ample wheelbase – no extra weight on turntable

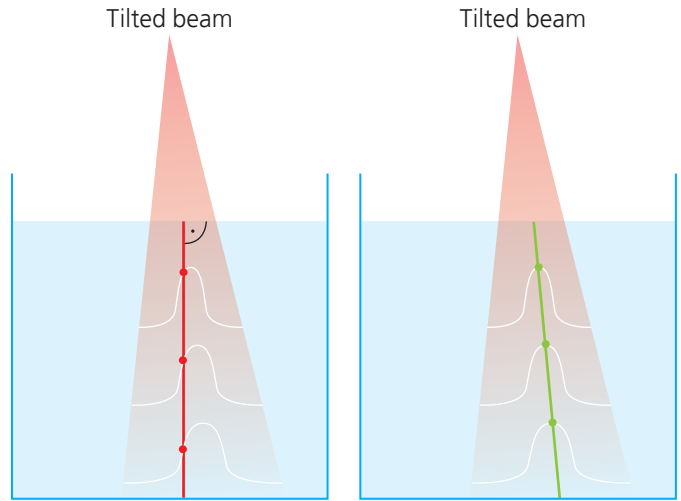
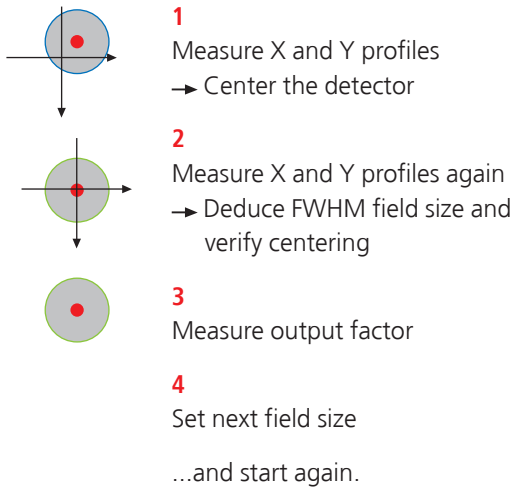

— BEAMSCAN measurement direction **before** correction
— BEAMSCAN measurement direction **after** correction

Taking all positioning and geometry information into account, this is the most accurate method to measure small field output factors.

Measures two profiles and calculates the shift in respect to the original zero position. Also the exact field size (FWHM) is measured.

Measure the beam inclination and set these angles for further measurements. The detector follows the inclination angles and measures always in beam center. Profiles are measured in different depth without CAX deviation.

Technical specifications

System

Total dimensions: 783 mm x 1548 mm x 1298/1798 mm
(W x D x min./max. H)
Total weight: Approx. 240 kg (empty), approx. 440 kg (filled)

3D water tank

Scanning range: 500 mm (horiz.) x 500 mm (horiz.) x
415 mm (vert.)
Wall thickness: 15 mm

Built-in electrometer

Channels: 2
Resolution: 10 fA
Chamber voltage: (0 ... ± 400) V, programmable in 1 V increments
Dynamic range: 2 pA ... 500 nA in three ranges
Non-linearity: ≤ ± 0.5 % acc. IEC 60731
Long-term stability: ≤ ± 0.5 % p.a. acc. IEC 60731
Reproducibility: ≤ ± 0.5 % acc. IEC 60731

Driving mechanism

Type: Stainless steel worm gear drive
Motor: Three stepper motors
Scanning mode: Continuous, step-by-step
Scanning speed: Up to 20 mm/s
Maximum speed: 50 mm/s
Min. step size: 0.1 mm

Lift carriage with built-in water reservoir

Moving range: 500 mm
Time for full lift: 45 s
Min. step size: < 1 mm
Pumping time: Approx. 5 min (filling), approx. 7 min (draining)



ptwbeamscan.com



Detectors for small field dosimetry

The perfect detector for each application

Semiflex 3D T31021

Very versatile 3D chamber for all tasks with equal size in all three dimensions. Output factors down to 2.5 cm (< 18 MV). Perfect for cross calibration in (4 x 4) cm² for daisy chaining (inter-mediate field method). Perfect for reference dosimetry in FFF beams.

Specifications

Type of product:	Vented cylindrical ionization chamber
Application:	Reference dosimetry in radiotherapy beams
Nominal sensitive volume:	0.07 cm ³
Polarity effect:	≤ ± 0.8 % (photons)
Field size:	(2.5 x 2.5) cm ² ... (40 x 40) cm ²

Ordering information

TN31021	Semiflex 3D chamber 0.07 cm ³ , connecting system BNT
TW31021	Semiflex 3D chamber 0.07 cm ³ , connecting system TNC
TM31021	Semiflex 3D chamber 0.07 cm ³ , connecting system M

PinPoint 3D T31022

Combines the advantages of an air-filled 3D chamber (fast scanning, good energy response) with a small detector size for dosimetry in photon beams. Perfect for profile measurements and accurate single-point dose measurements in RUBY.

Specifications

Type of product:	Vented cylindrical ionization chamber
Application:	Dosimetry in photon beams
Nominal sensitive volume:	0.016 cm ³
Polarity effect:	≤ ± 0.8 % (photons)
Field size:	(2 x 2) cm ² ... (40 x 40) cm ²
Small fields ¹ :	Down to 0.8 cm

Ordering information

TN31022	PinPoint 3D chamber 0.016 cm ³ , connecting system BNT
TW31022	PinPoint 3D chamber 0.016 cm ³ , connecting system TNC
TM31022	PinPoint 3D chamber 0.016 cm ³ , connecting system M

microDiamond T60019

The all-in-one detector for photon and electron dosimetry. Its very good energy response and small volume makes it perfectly suited for small field measurements and also for large fields. Corrections are less than 5 % for all small field sizes of AAPM/IAEA TRS 483.

Specifications

Type of product: Synthetic single crystal diamond detector
Application: Relative dosimetry in radiotherapy beams
Nominal sensitive volume: 0.004 mm³
Nominal response: 1 nC/Gy
Field size: (1 x 1) cm² ... (40 x 40) cm²
Small fields¹: Down to 0.4 cm

Ordering information

TN60019 microDiamond, connecting system BNT
TW60019 microDiamond, connecting system TNC
TM60019 microDiamond, connecting system M

microSilicon T60023

Excellent small field detector, combining small volume with the high response of silicon. Corrections less than 5 % for all small field sizes of AAPM/IAEA TRS 483.

Specifications

Type of product: p-type silicon diode
Application: Relative dosimetry in radiotherapy beams
Nominal sensitive volume: 0.03 mm³
Nominal response: 19 nC/Gy
Field size: (1 x 1) cm² ... (10 x 10) cm² (photons)
Small fields¹: Down to 0.4 cm

Ordering information

TN60023 microSilicon, connecting system BNT
TW60023 microSilicon, connecting system TNC
TM60023 microSilicon, connecting system M

T-REF T34091

Excellent low-noise reference chamber for fast scanning in small field dosimetry of field sizes (5 x 5) cm² and below.

Specifications

Type of product: Vented plane-parallel ionization chamber
Application: Reference for relative dosimetry in high-energy small field photon beams
Nominal sensitive volume: 10.5 cm³
Nominal response: 325 nC/Gy (at ⁶⁰Co free in air)
Total area density: 72 mg/cm²
Max. field size: (5 x 5) cm² (at measurement location)

Ordering information

TN34091 T-REF chamber, connecting system BNT including holder
TW34091 T-REF chamber, connecting system TNC including holder
TM34091 T-REF chamber, connecting system M including holder

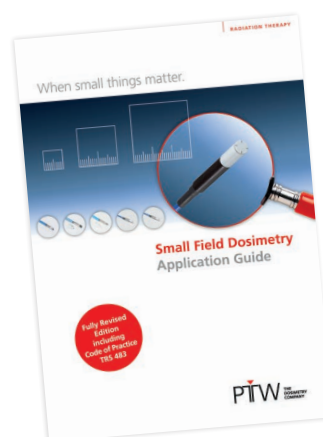

For more information have a look at the PTW Small Field Dosimetry Application Guide or use our online tool "Detector Selector".



Semiflex 3D



PinPoint 3D



microDiamond



microSilicon



T-REF

¹ This detector is well suited for measurements in small and very small fields. Please note that for high accuracy measurements any detector may need correction factors in small fields. The small field size limit is provided as equivalent square field size following the methodology of IAEA TRS 483:2017.



The Dosimetry School

Small field dosimetry, IMRT/VMAT patient plan verification and Linac QA

The course provides basic knowledge in a compact form about the new Code of Practice IAEA TRS 483 standard for the clinical dosimetry of small regular and irregular photon radiation fields, as they are used in stereotactic and fluence-modulated radiation therapy (IMRT), rotational radiation (e.g. VMAT, tomotherapy) and high-energy gamma and photon radiation. The focus is on the application of the standard in clinical practice.

Among other things, recommended measuring methods with reference ionization chambers and suitable calibrated

detectors as well as important correction factors are presented. On the basis of real examples, typical problems in the dosimetry of small fields are shown and suitable solutions are discussed.

The course addresses key issues in small field dosimetry, patient plan verification and Linac commissioning and QA. As such, it is very well suited for medical physicists who want to update and extend their skills and knowledge of practical dosimetry.

PTW Freiburg GmbH
Lörracher Str. 7
79115 Freiburg · Germany
Phone +49 761 49055-0
Fax +49 761 49055-70
info@ptwdosimetry.com

ptwdosimetry.com

© PTW. All Rights Reserved. Specifications subject to change without prior notice.
All trademarks mentioned in this document are the property of their respective owners.
D913.139.05/02 2023-02

PTW
THE
DOSIMETRY
COMPANY