

Complete Solutions for Small Field Applications

PRODUCT OVERVIEW

When small things matter.

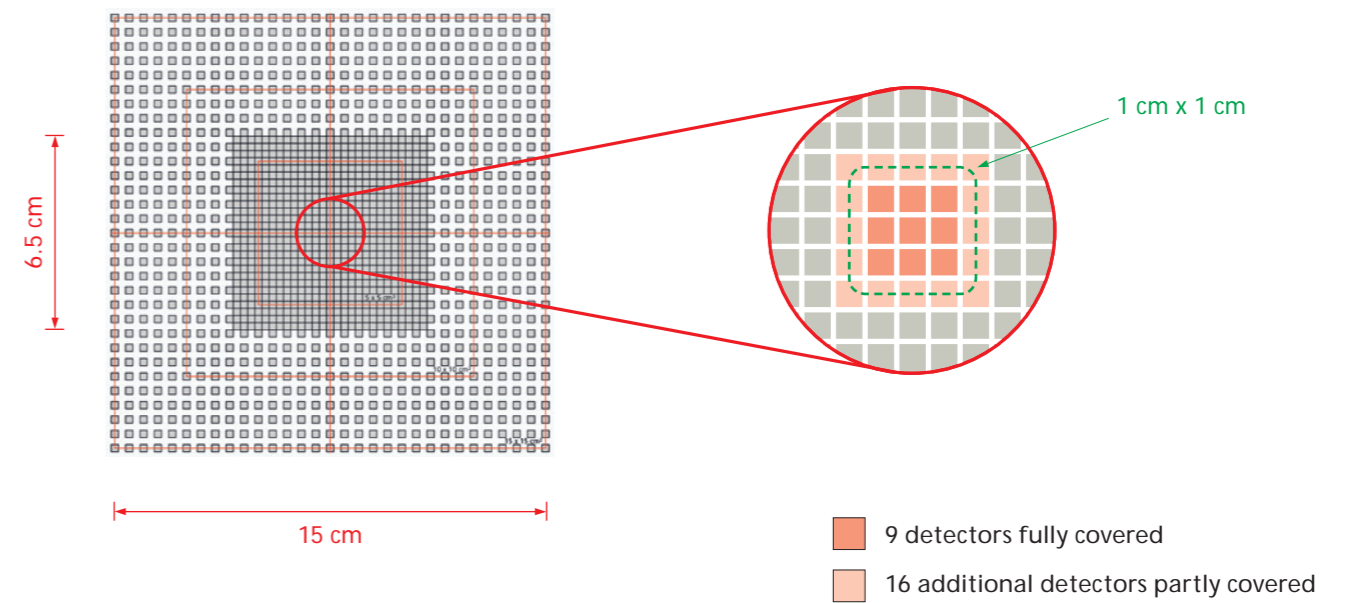

Optimal size for multi target SRS treatments

Stereotactic treatments require high radiological and, most importantly, spatial precision which should be checked for each patient individually. Besides 2D patient plan verification OCTAVIUS Detector 1600^{SRS} allows independent 3D patient plan verification when combined with OCTAVIUS 4D. Due to its high spatial resolution (2.5 mm) and its large detector area of 15 x 15 cm² OCTAVIUS 1600 SRS allows patient specific QA of SRS treatments, especially of those including multiple, widely-spaced target volumes (e.g. multiple metastases in stereotactic brain applications).

- 3D verification of multiple, widely-spaced target volumes within a single measurement
 - No repeated and time-consuming measurements of individual/grouped target volumes requiring couch or detector shifts
- Calculation of 3D volume gamma metrics and translational offsets for evaluation of radiological and spatial precision

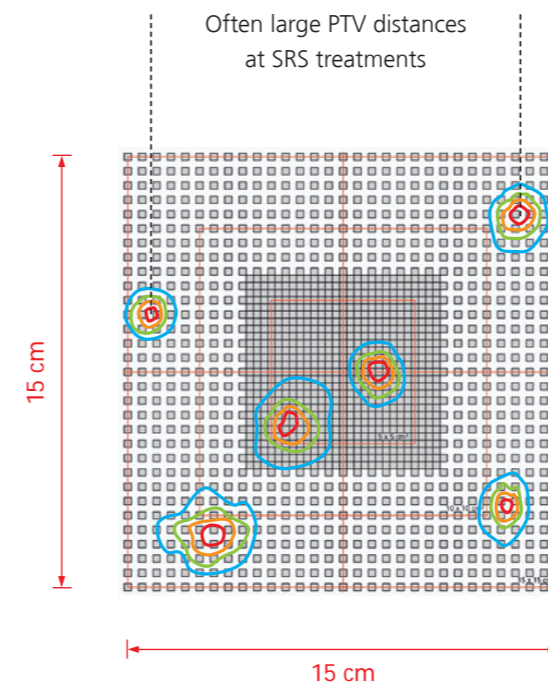

Recently TPS and Linac manufacturers introduced new solutions for efficient planning of SRS treatments of multiple target volumes with a single isocenter (e.g. Varian HyperArc and Brainlab Elements[®] Multiple Brain Mets SRS). These applications often include multiple widely-spaced target volumes easily covered with the large detector area of 15 x 15 cm².

OCTAVIUS[®] Detector 1600^{SRS}

with OCTAVIUS 4D

OCTAVIUS Detector 1600^{SRS} Unique Detector Properties

- ▶ Advancement of well-established OCTAVIUS Detector 1000 SRS with > 50% more chambers
- ▶ 1521 liquid-filled ionization chambers with an active volume of 2.5 x 2.5 x 0.5 mm³ (0.003 cm³)
- ▶ Enlarged active detector area with 15 x 15 cm²
- ▶ 729 ionization chambers in enlarged high-resolution center area of 6.5 x 6.5 cm²
- ▶ Spatial resolution 2.5 mm in center area
- ▶ For filmless patient plan verification and machine specific QA
- ▶ Excellent error detection for all stereotactic treatment plans

Patient specific phantom adaption

For measurements with OCTAVIUS 4D the OCTAVIUS Detector 1600^{SRS} can be used with the OCTAVIUS Top SRS plus. With a diameter of 21 cm the resulting homogeneous cylinder geometry adapts the anatomy of a human head perfectly in SRS treatments of the brain.

In addition, for either SBRT procedures (e.g. stereotactic treatment of lung metastases) or other clinical entities the OCTAVIUS Detector 1600^{SRS} can be combined with the 32 cm OCTAVIUS Top Standard, emphasizing its multifunctional nature.

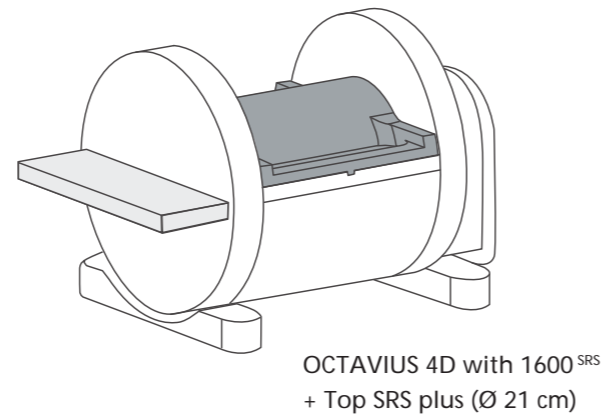

Patient dose distribution of a multiple target SRS treatment

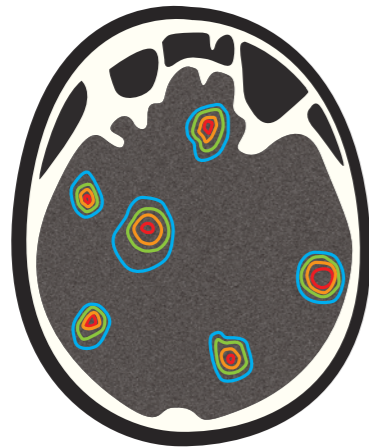

Phantom dose distribution

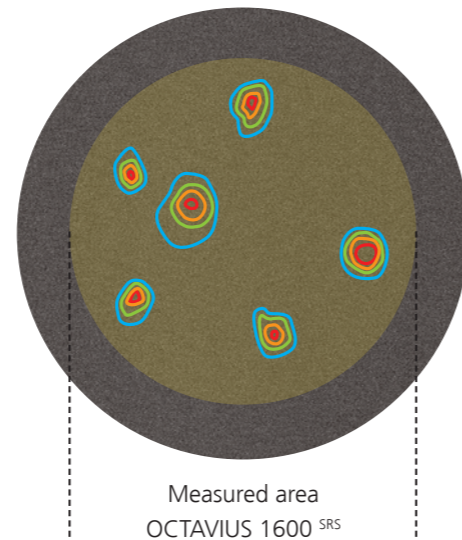

Commissioning of SRS/SBRT techniques

PTW OCTAVIUS Detectors have proven to be accurate tools for planar dose measurements. Especially for radiotherapy departments implementing SRS/SBRT delivery techniques into their clinical practice, OCTAVIUS 1600^{SRS} can support and facilitate the commissioning process.



True verification of non-coplanar SRS treatments

Conventional SRS treatments and especially modern single-isocenter SRS treatments, such as Varian HyperArc™ or Brainlab Elements® Multiple Brain Mets SRS, use a mixture of coplanar and non-coplanar beams improving the dose conformity. Together with OCTAVIUS 4D the new OCTAVIUS Detector 1600^{SRS} represents an ideal tool for true 3D verification of SRS treatments with non-coplanar beams.

- True and simple 3D verification of SRS deliveries with non-coplanar beams
 - Verification of the real patient plan - no need to collapse couch angles to 0°
 - VeriSoft automatically reads out all couch angles from the DICOM RT Plan and takes them into account for dose reconstruction
- Arbitrary couch angles up to 90°/270° supported
 - No limitation of couch angles with respect to beam quality

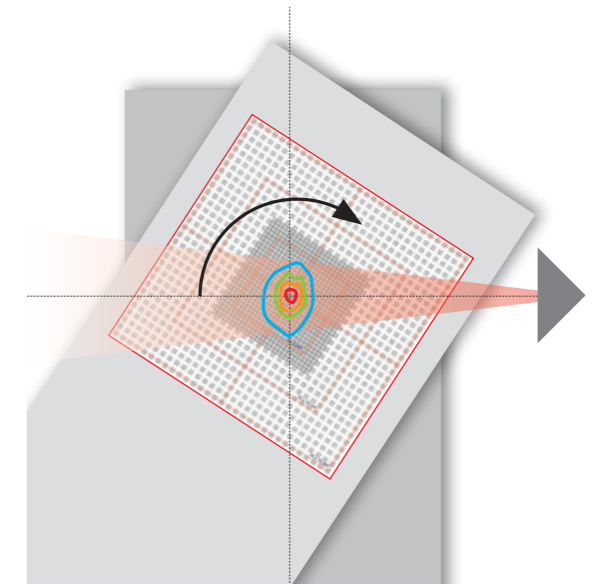

VeriSoft takes arbitrary couch angles into account

Technical specifications

OCTAVIUS Detector 1600^{SRS}

Type of product:	Two-dimensional array with 1521 liquid-filled ionization chambers
Application:	IMRT and VMAT patient plan verification Machine-specific QA Online beam adjustment
Measuring quantities:	Absorbed dose rate and absorbed dose
Range of use:	0.1 - 24 Gy/min
Resolution:	0.1 mGy, 0.1 mGy/min
Dead time:	Zero
Display cycle:	100 - 800 ms
Type of detectors:	Plane-parallel, liquid-filled ionization chambers
Detector layout:	Center area (6.5 cm x 6.5 cm): spacing 2.5 mm Outer area (15 cm x 15 cm): spacing 5 mm
Nominal response:	16 nC/Gy
Size of detectors:	2.5 mm x 2.5 mm x 0.5 mm (0.003 cm ³)
Active detector area:	15 cm x 15 cm
Outer dimensions:	300 mm x 420 mm x 22 mm (W x D x H)
Weight:	5.9 kg

Ordering information

L981626	OCTAVIUS 4D system, 1600 ^{SRS}
L981628	OCTAVIUS Detector 1600 ^{SRS} measuring system
L981627	OCTAVIUS I, 1600 ^{SRS} incl. VeriSoft software
L981642	OCTAVIUS Det. 1600 ^{SRS} , upgrade (1000 SRS)
L981454	Accessory package CyberKnife®

OCTAVIUS 4D modular phantom

Design:	Motorized, modular phantom, consisting of base unit with three exchangeable tops
Dimensions:	Phantom diameter 320 mm, length 343 mm
Weight:	Base unit 20.7 kg
Angle range:	± 360°
Material:	Polystyrene
Density:	1.05 g/cm ³

Phantom tops

Top Standard:	Phantom diameter 320 mm weight 8.9 kg
Top SRS:	Phantom diameter 170 mm weight 2.3 kg
Top SRS plus:	Phantom diameter 210 mm weight 3.7 kg
Top Linac QA:	50 mm water-equivalent build-up weight 2.2 kg

Ordering information

T40063	OCTAVIUS Rotation Unit modular
T40063.1.004	OCTAVIUS Top Standard
T40063.1.002	OCTAVIUS Top SRS
T40063.1.005	OCTAVIUS Top SRS plus
T40063.1.003	OCTAVIUS Top Linac QA

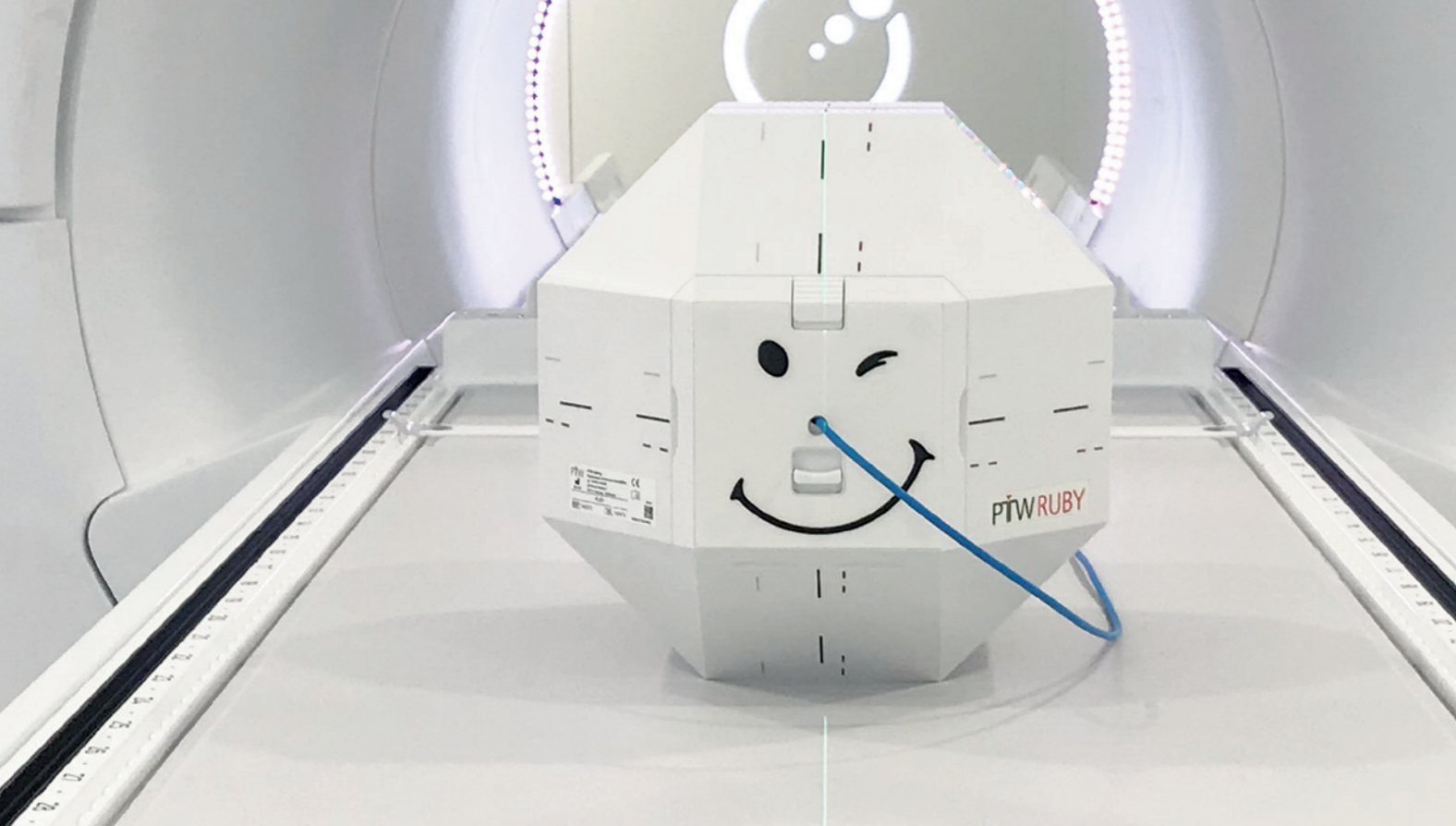

RUBY

The new modular phantom platform for high-precision radiotherapy and SRS/SBRT QA

One phantom. Multiple inserts. All tasks.

- ▶ Technologically advanced, new modular phantom platform with powerful, ready-to-use application-specific inserts
- ▶ Unrivaled flexibility – add and combine inserts as needed
- ▶ Fast, simple system setup and operation – insert and start testing
- ▶ Comprehensive end-to-end testing of the entire SRS/SBRT treatment process with the System QA insert
- ▶ Measurement-based patient-specific plan verification, including non-coplanar treatments, with film and different detector types
- ▶ Alignment checks of the entire system, including 6D couches
- ▶ CT markers in phantom and all inserts for enhanced visibility
- ▶ Tissue-equivalent materials that follow ICRU-44/-46 standards
- ▶ Supports the latest radiotherapy treatment techniques and systems, including SRS, SBRT, SGRT, Varian Halcyon™ and Elekta Unity
- ▶ All components designed and manufactured with submillimeter precision
- ▶ Integrated, compatible solution – phantom, inserts, detectors from one single source

System QA

- ▶ Comprehensive end-to-end testing and patient QA of stereotactic treatments (SRS, SBRT, SRT) as recommended in major QA protocols and guidelines
- ▶ Tissue equivalent materials (bone, brain and lung)
- ▶ Clinically tested MRI visibility in all commonly used sequences (T1, T2) – no additional components required
- ▶ Accurate single-point dose measurements

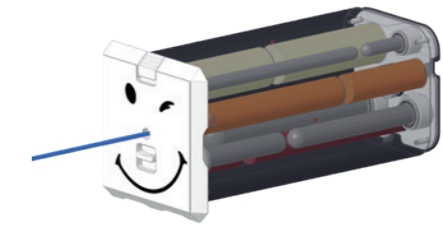

RUBY Insert "End-to-End Test" for System QA

Linac QA

- ▶ Daily checks of IGRT and SGRT positioning accuracy, including remote-controlled couches (including 6D) as recommended by AAPM TG-179 and TG-142
- ▶ Tissue-equivalent bone structures for enhanced visibility in kV and MV images
- ▶ High-density radiopaque sphere at isocenter for easy Winston-Lutz testing

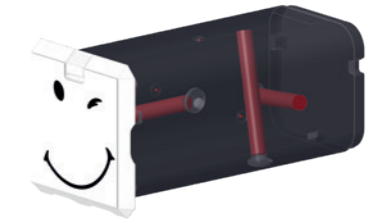

RUBY Insert "Alignment/Isocenter Check" for Linac QA

Patient QA

Detector Insert

- ▶ One insert for fast, accurate single-point dose measurements with different detector types
- ▶ Unique "Plug and Measure" convenience using detector holders – no need to replace phantom or exchange inserts

Film Insert

- ▶ Homogeneous insert designed for use with high-resolution radiochromic films
- ▶ Film-based patient plan verification for high-precision radiotherapy and SBRT/SRS

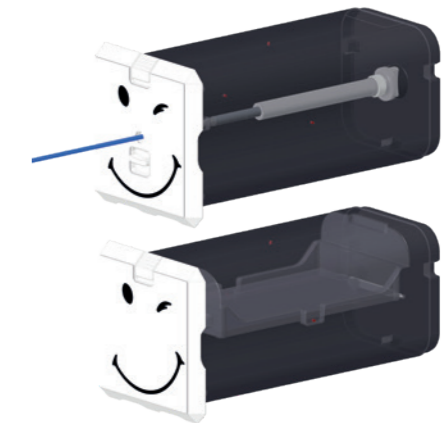

RUBY Insert "Detector" and RUBY Insert "Film" for Patient QA

Technical specifications

RUBY phantom

Design:	Polyhedron phantom with octahedral symmetry (10 cm side length) and cubic hole for QA test inserts in phantom center	
Laser alignment marks:	Black:	phantom center
	Gray:	translational shift (coronal: 18 mm; transversal: 14 mm; sagittal: -25 mm)
	Red:	translational and rotational shift (coronal: -12 mm, rotation -1°; transversal: -10 mm, rotation 2.5°; sagittal: 15 mm, rotation -1.5°)
Material:	Polystyrene	
Density:	1.05 g/cm ³	
Dimensions:	241.4 mm x 231.4 mm x 241.4 mm (W x D x H)	
Weight:	6.7 kg	

Ordering information

L981635	RUBY Set All-inclusive
L981636	RUBY Set System QA
L981637	RUBY Set Linac QA
L981638	RUBY Set Patient QA

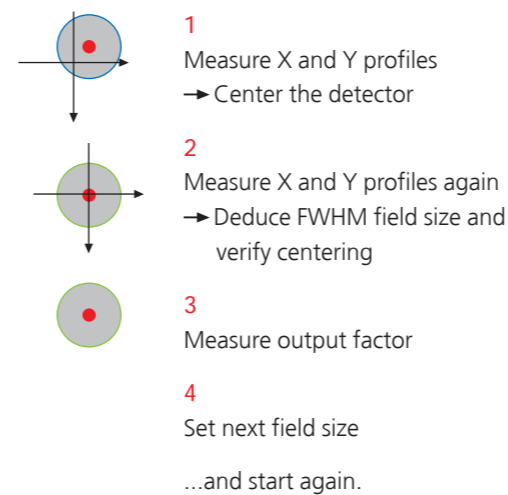
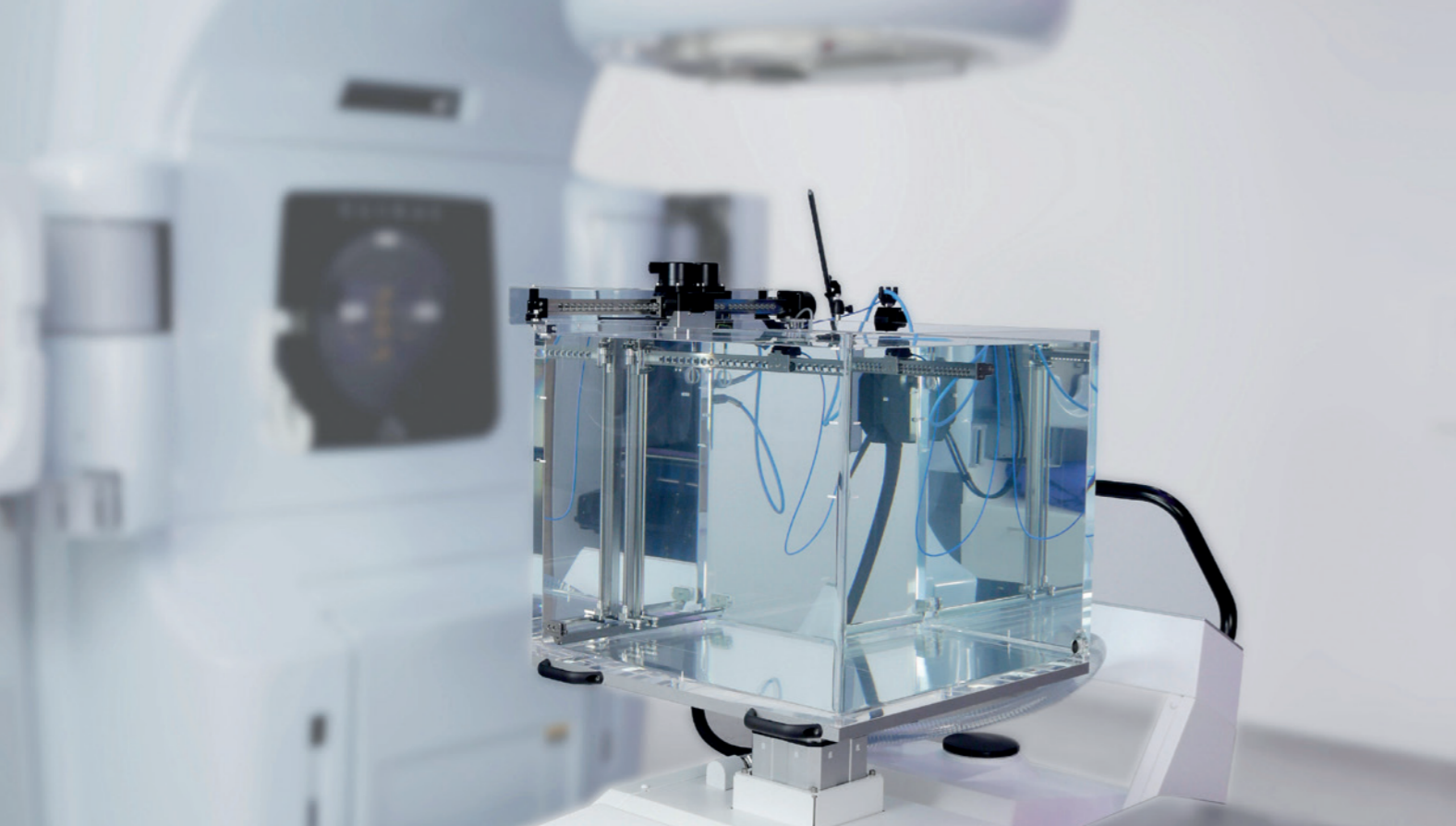

Taking all positioning and geometry information into account, this is the most accurate method to measure small field output factors.

Measures two profiles and calculates the shift in respect to the original zero position. Also the exact field size (FWHM) is measured.

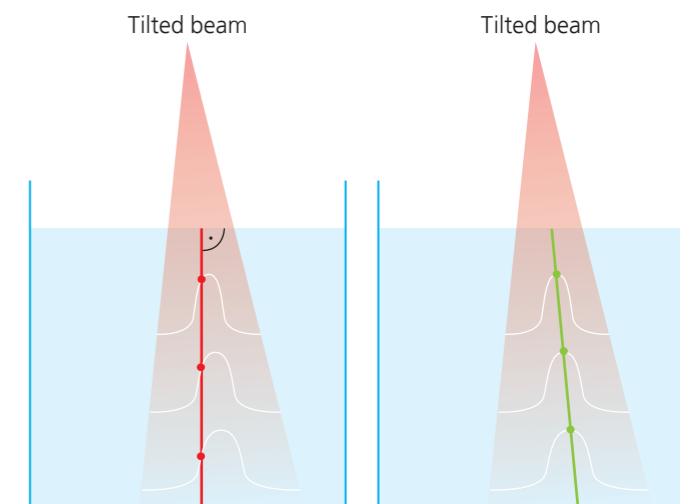

— BEAMSCAN measurement direction **before** correction
— BEAMSCAN measurement direction **after** correction

Measure the beam inclination and set these angles for further measurements. The detector follows the inclination angles and measures always in beam center. Profiles are measured in different depth without CAX deviation.

BEAMSCAN®

The new motorized water phantom - also for small fields

True all-in-one 3D water scanning system with wireless auto setup and operation

Measurements in small fields are always a challenge and at the same time a commitment for PTW to manage these measurements at its best.

The new BEAMSCAN SW 4.4 with dedicated features for small field dosimetry in combination with the high mechanical precision and the Auto Setup features makes BEAMSCAN the best choice for small field dosimetry.

The measured beam inclination will be taken into account for other measurements.

Output factors are always measured in the beam maximum when the new function "Search maximum" is used before measurement of output factors.

- ▶ Fast, fully automated, wireless setup with BEAMSCAN™ Wizard using
- ▶ Patented, fully automatic virtual tank leveling
- ▶ Wireless operation and data transfer
- ▶ Fast scanning (up to 20 mm/s)
- ▶ Supports Varian Halcyon™
- ▶ Continuous and step-by-step scanning mode
- ▶ Fully automatic water filling/draining
- ▶ Auto field alignment

- ▶ Advanced stainless steel worm drive with wave prevention
- ▶ Built-in, high-precision electrometer
- ▶ Reference-class Semiflex 3D ionization chambers as detectors, suitable for a wide range of field sizes
- ▶ TPR measurement already included
- ▶ Integrated evaporation control
- ▶ Easy clip-in detector installation with new TRUFIX^{BS}
- ▶ Water tank with inclined bottom for complete draining
- ▶ Ample wheelbase – no extra weight on turntable

Technical specifications

System	
Total dimensions:	783 mm x 1548 mm x 1298/1798 mm (W x D x min./max. H)
Total weight:	Approx. 240 kg (empty), approx. 440 kg (filled)
3D water tank	
Scanning range:	500 x mm (horiz.) x 500 mm (horiz.) x 415 mm (vert.)
Wall thickness:	15 mm
Built-in electrometer	
Channels:	2
Resolution:	10 fA
Chamber voltage:	(0 ... ± 400) V, programmable in 1 V increments
Dynamic range:	2 pA ... 500 nA in three ranges
Non-linearity:	≤ ± 0.5 % acc. IEC 60731
Long-term stability:	≤ ± 0.5 % p.a. acc. IEC 60731
Reproducibility:	≤ ± 0.5 % acc. IEC 60731
Driving mechanism	
Type:	Stainless steel worm gear drive
Motor:	Three stepper motors
Scanning mode:	Continuous, step-by-step
Scanning speed:	Up to 20 mm/s
Maximum speed:	50 mm/s
Min. step size:	0.1 mm
Lift carriage with built-in water reservoir	
Moving range:	500 mm
Time for full lift:	45 s
Min. step size:	< 1 mm
Pumping time:	Approx. 5 min (filling), approx. 7 min (draining)



ptwbeamscan.com



Detectors for small field dosimetry

The perfect detector for each application

Semiflex 3D T31021

Very versatile 3D chamber for all tasks with equal size in all three dimensions. Output factors down to 2.5 cm (< 18 MV). Perfect for cross calibration in (4 x 4) cm² for daisy chaining (intermediate field method). Perfect for reference dosimetry in FFF beams.

Specifications

Type of product: Vented cylindrical ionization chamber
 Application: Absolute dosimetry in radiotherapy beams
 Nominal sensitive volume: 0.07 cm³
 Polarity effect: $\leq \pm 0.8\%$ (photons)
 Field size: (2.5 x 2.5) cm² ... (40 x 40) cm²

Ordering information

TN31021 Semiflex 3D chamber 0.07 cm³, connecting system BNT
 TW31021 Semiflex 3D chamber 0.07 cm³, connecting system TNC
 TM31021 Semiflex 3D chamber 0.07 cm³, connecting system M

PinPoint 3D T31022

Combines the advantages of an air-filled 3D chamber (fast scanning, good energy response) with a small detector size for dosimetry in photon beams. Perfect for profile measurements and accurate single-point dose measurements in RUBY.

Specifications

Type of product: Vented cylindrical ionization chamber
 Application: Absolute/relative dosimetry in photon beams
 Nominal sensitive volume: 0.016 cm³
 Polarity effect: $\leq \pm 0.8\%$ (photons)
 Field size: (2 x 2) cm² ... (40 x 40) cm²
 Small fields¹: Down to 0.8 cm

Ordering information

TN31022 PinPoint 3D chamber 0.016 cm³, connecting system BNT
 TW31022 PinPoint 3D chamber 0.016 cm³, connecting system TNC
 TM31022 PinPoint 3D chamber 0.016 cm³, connecting system M

microDiamond T60019

The all-in-one detector for photon and electron dosimetry. Its very good energy response and small volume makes it perfectly suited for small field measurements and also for large fields. Corrections are less than 5 % for all small field sizes of AAPM/IAEA TRS 483.

Specifications

Type of product: Synthetic single crystal diamond detector
 Application: Relative dosimetry in radiotherapy beams
 Nominal sensitive volume: 0.004 mm³
 Nominal response: 1 nC/Gy
 Field size: (1 x 1) cm² ... (40 x 40) cm²
 Small fields¹: Down to 0.4 cm

Ordering information

TN60019 microDiamond Detector, connecting system BNT
 TW60019 microDiamond Detector, connecting system TNC
 TM60019 microDiamond Detector, connecting system M

microSilicon T60023

Excellent small field detector, combining small volume with the high response of silicon. Corrections less than 5 % for all small field sizes of AAPM/IAEA TRS 483.

Specifications

Type of product: p-type silicon diode
 Application: Relative dosimetry in radiotherapy beams
 Nominal sensitive volume: 0.03 mm³
 Nominal response: 19 nC/Gy
 Field size: (1 x 1) cm² ... (10 x 10) cm² (photons)
 Small fields¹: Down to 0.4 cm

Ordering information

TN60023 microSilicon, connecting system BNT
 TW60023 microSilicon, connecting system TNC
 TM60023 microSilicon, connecting system M

T-REF T34091

Excellent low-noise reference chamber for fast scanning in small field dosimetry of field sizes (5 x 5) cm² and below.

Specifications

Type of product: Vented plane-parallel ionization chamber
 Application: Relative dosimetry in high-energy photon beams
 Nominal sensitive volume: 10.5 cm³
 Nominal response: 325 nC/Gy (at ⁶⁰Co free in air)
 Total area density: 206 mg/cm²
 Max. field size: (5 x 5) cm² (at measurement location)

Ordering information

TN34091 T-REF chamber, connecting system BNT including holder
 TW34091 T-REF chamber, connecting system TNC including holder
 TM34091 T-REF chamber, connecting system M including holder

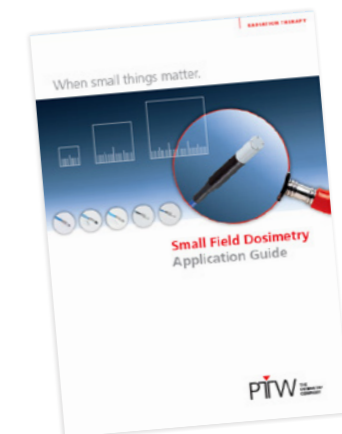

For more information have a look at the PTW Small Field Dosimetry Application Guide.



Semiflex 3D



PinPoint 3D



microDiamond



microSilicon



T-REF

¹ This detector is well suited for measurements in small and very small fields. Please note that for high accuracy measurements any detector may need correction factors in small fields. The small field size limit is provided as equivalent square field size following the methodology of IAEA TRS 483:2017.



The Dosimetry School

Small field dosimetry, IMRT/VMAT patient plan verification and Linac QA

The course provides basic knowledge in a compact form about the new Code of Practice IAEA TRS 483 standard for the clinical dosimetry of small regular and irregular photon radiation fields, as they are used in stereotactic and fluence-modulated radiation therapy (IMRT), rotational radiation (e.g. VMAT, tomotherapy) and high-energy gamma and photon radiation. The focus is on the application of the standard in clinical practice.

Among other things, recommended measuring methods with reference ionization chambers and suitable calibrated detectors

as well as important correction factors are presented. On the basis of real examples, typical problems in the dosimetry of small fields are shown and suitable solutions are discussed.

The course addresses key issues in small field dosimetry, patient plan verification and Linac commissioning and QA. As such, it is very well suited for medical physicists who want to update and extend their skills and knowledge of practical dosimetry.

PTW Freiburg GmbH
Lörracher Str. 7
79115 Freiburg · Germany
Phone +49 761 49055-0
Fax +49 761 49055-70
info@ptwdosimetry.com

ptwdosimetry.com

© PTW. All Rights Reserved. Specifications subject to change without prior notice.
All trademarks mentioned in this document are the property of their respective owners.
D913.139.05/01 2020-07

PTW
THE
DOSIMETRY
COMPANY